

Twin-LCD Monitor Arm

Specification







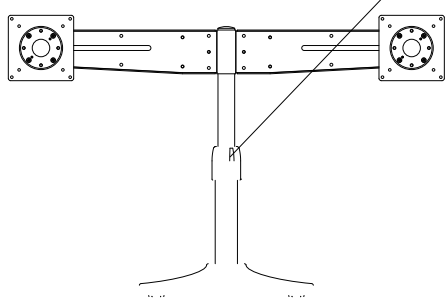



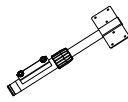

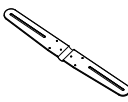
Desk Swivel Arm stand for Twin LCD Monitor.

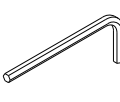
Key Specifications/Special Features:

1. Apply for any 15"~20" LCD Monitor which backside meet VESA standards (75*75mm/100*100mm)
2. Superior flexibility and movement
3. Swivel left & right: $\pm 15^\circ$
4. Pivot up & down: $\pm 20^\circ$
5. Monitor swivel: 360
6. Horizontal moving dist.: 289~635mm
7. Vertical moving dist.: 300~425mm
8. Max load 15kgs/per one monitor



Part List

ITEM	1	2	3	4	5	6
PARTS						
GTY		1	1	6	1	2
ITEM	7	8	9	10	11	
PARTS						
GTY	2	2	4	2	8	8

Twin-LCD Monitor Arm

Installation

